



EXAM PAPERS PRACTICE

Boost your performance and confidence with these topic-based exam questions

Practice questions created by actual examiners and assessment experts

Detailed mark scheme

Suitable for all boards

Designed to test your ability and thoroughly prepare you

2002

XVIII

1583

Time allowed
24 Minutes

Score

/20

Percentage

%

Physics

**AQA
AS & A LEVEL**

Topic Questions

2. Waves

www.exampaperspractice.co.uk

1 A stone is projected horizontally by a catapult consisting of two rubber cords. The cords, which obey Hooke's law, are stretched and released. When each cord is extended by x , the stone is projected with a speed v . Assuming that all the strain energy in the rubber is transferred to the stone, what is the speed of the stone when each cord is extended by $2x$?

- A v
- B $\sqrt{2}v$
- C $2v$
- D $4v$

(Total 1 mark)

2 The diagram shows the graph of force on a car against time when the car of mass 500 kg crashes into a wall without rebounding.

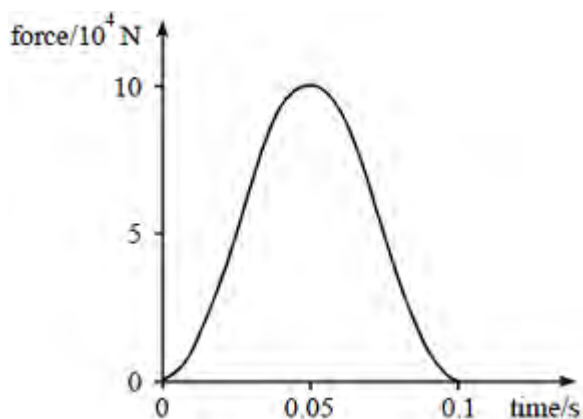

Which one of the following statements is correct?

- A The area under the graph is equal to the initial momentum of the car
- B Momentum is not conserved in the collision
- C Kinetic energy is conserved in the collision
- D The average force exerted on the car is 10×10^4 N

(Total 1 mark)

- 3 A perfectly elastic rubber ball falls vertically from rest and rebounds from the floor. Which one of the following velocity-time, $v-t$, graphs best represents the motion from the moment of release to the top of the first rebound?

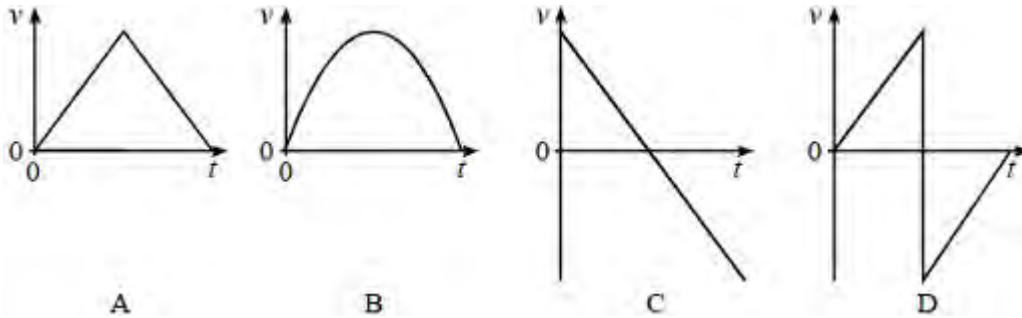

(Total 1 mark)

- 4 The diagram shows a strobe photograph of a mark on a trolley **X**, moving from right to left, in collision with another trolley **Y** which had no mark on it.

After the collision both trolleys are in motion together.



Which **one** of the following is consistent with the photograph?

- A Trolley **Y** has the same mass as trolley **X** and was initially stationary
- B Trolley **Y** had a smaller mass than **X** and was moving from right to left
- C Trolley **Y** had the same mass and was initially moving left to right at the same speed as trolley **X**
- D Trolley **Y** had the same mass and was initially moving left to right at a higher speed than trolley **X**

(Total 1 mark)

- 5 The force on a sample of a material is gradually increased and then decreased. The graph of force against extension is shown in the diagram.

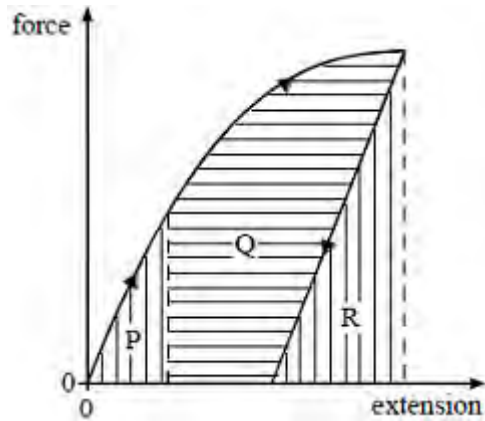

The increase in thermal energy in the sample is represented by area

- A R
- B $P + Q$
- C $P + Q + R$
- D $P + Q - R$

(Total 1 mark)

6

The diagram shows a uniform door hanging from two hinges 2.5 m apart.

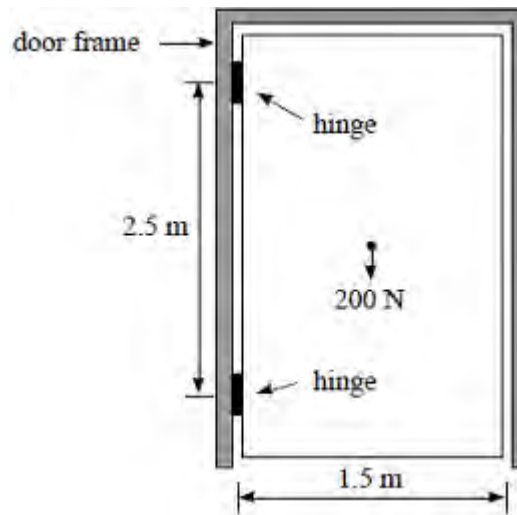

The moment of the couple that the hinges exert on the door is

- A 150 N m
- B 200 N m
- C 250 N m
- D 500 N m

(Total 1 mark)

For more help please visit our website www.exampaperspractice.co.uk

- 7 A pivoted metre rule is supported in equilibrium horizontally by a thread inclined at 30° to the vertical.

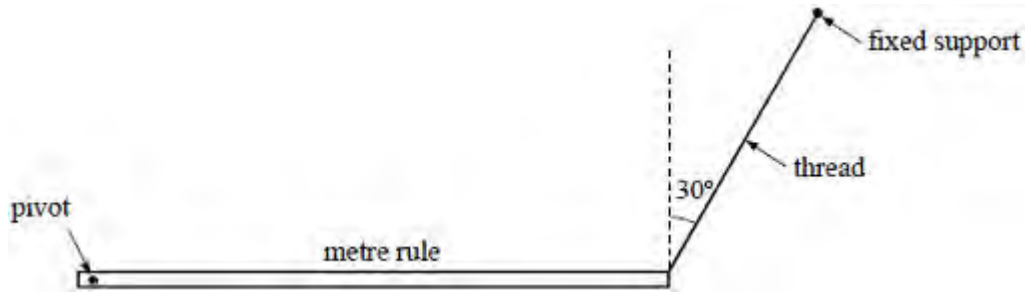

The three forces acting on the rule are:

- its weight W ;
- the tension T in the thread;
- the reaction force R at the pivot.

Which one of these diagrams, drawn to scale, represents the magnitudes and directions of these three forces?

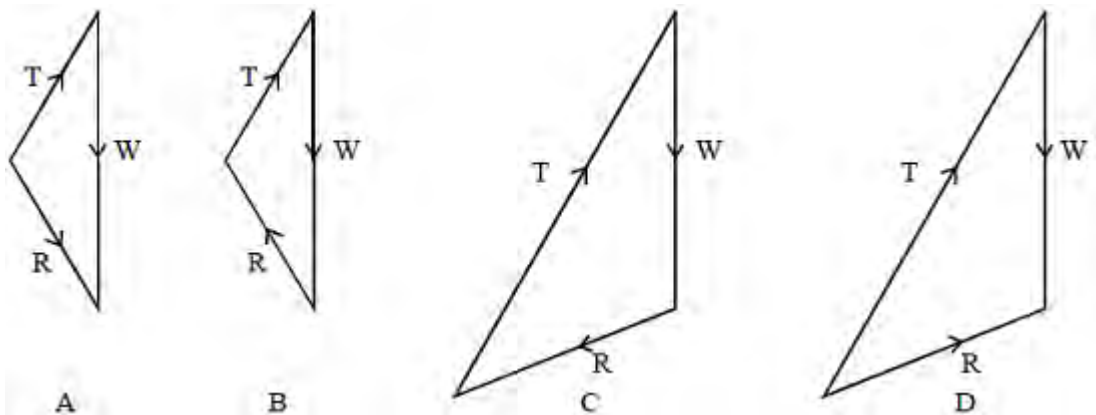

(Total 1 mark)

- 8 The diagram shows a metal rod suspended in a magnetic field by two vertical conducting springs. The cell and rod have negligible resistance. When the switch **S** is closed the effect of the magnetic field is to displace the rod vertically a distance y .

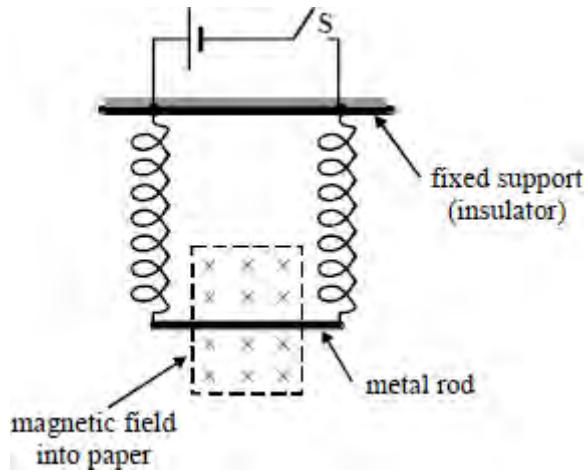

When both the spring constant and electrical resistance of **each** spring is doubled, closing the switch would now cause the rod to be displaced a distance

- A $\frac{y}{2}$
- B $\frac{y}{4}$
- C y
- D $4y$

(Total 1 mark)



- 9 A raindrop of mass m falls to the ground at its terminal speed v . The specific heat capacity of water is c and the acceleration of free fall is g . Given that 25% of the energy is retained in the raindrop when it strikes the ground, what is the rise in temperature of the raindrop?

A $\frac{mv^2}{8c}$

B $\frac{v^2}{4mc}$

C $\frac{mg}{4c}$

D $\frac{v^2}{8c}$

(Total 1 mark)



10 A steel ball of weight W falls through oil. At a time **before** the ball reaches terminal velocity, the magnitude of the viscous resistance force on the ball is

- A zero
- B between zero and W
- C equal to W
- D greater than W

(Total 1 mark)

11 A load of 4.0 N is suspended from a parallel two-spring system as shown in the diagram.

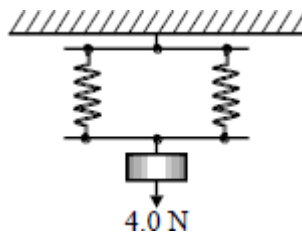

The spring constant of each spring is 20 N m^{-1} . The elastic energy, in J, stored in the system is

- A 0.1
- B 0.2
- C 0.4
- D 0.8

(Total 1 mark)



12

The diagrams show the variation of velocity and acceleration with time for a body undergoing simple harmonic motion.

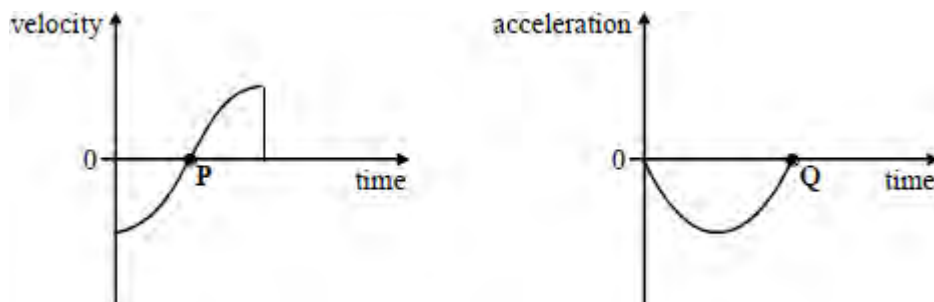

Which one of the following is proportional to the change in momentum of the body during the time covered by the graphs?

- A The area enclosed by the velocity-time graph and the time axis
- B The gradient of the velocity-time graph at the point P
- C The area enclosed by the acceleration-time graph and the time axis
- D The gradient of the acceleration-time graph at the point Q

(Total 1 mark)

- 13 The rectangular objects, **A**, **B**, **C** and **D** are each 2 cm long and 1 cm high. Which one of the bodies is in equilibrium?

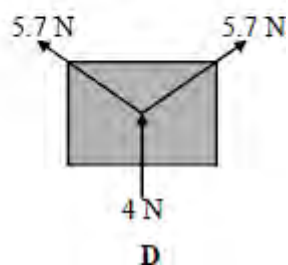
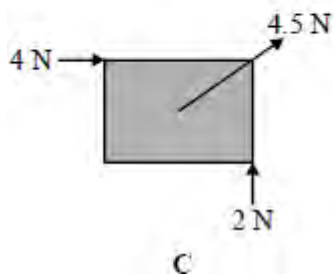
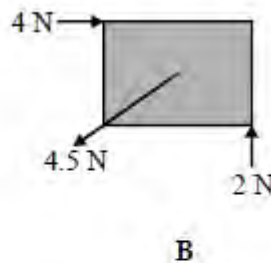
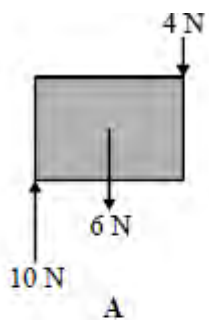

(Total 1 mark)



- 14 A uniform square block is sliding with uniform speed along a rough surface as shown in the diagram.

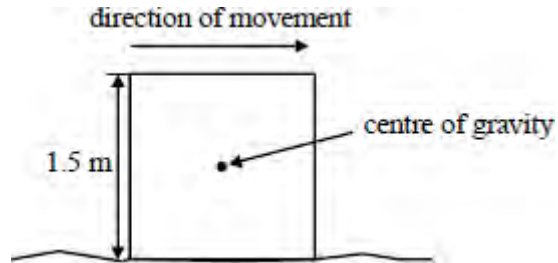

The force used to move the block is 200 N. The moment of the frictional force acting on the block about the centre of gravity of the block is

- A 150 N m, clockwise
- B 150 N m, anticlockwise
- C 300 N m, clockwise
- D 300 N m, anticlockwise

(Total 1 mark)

- 15 Which one of the following pairs contains one vector and one scalar quantity?

A	Displacement	Acceleration
B	Force	Kinetic energy
C	Power	Speed
D	Work	Potential energy

(Total 1 mark)



16 Which of the following does **not** give a value in seconds?

A capacitance \times resistance

B $\frac{1}{\text{frequency}}$

C half-life

D $\frac{\text{power}}{\text{work}}$

(Total 1 mark)

17 A car of mass M travelling at speed V comes to rest using its brakes. Energy is dissipated in the brake discs of total mass m and specific heat capacity c . The rise in temperature of the brake discs can be estimated from

A $\frac{mV^2}{2Mc}$

B $\frac{2MV^2}{mc}$

C $\frac{MV^2}{2mc}$

D $\frac{2mc}{MV^2}$

(Total 1 mark)



- 18 A body X, moving with a velocity v , collides elastically with a stationary body Y of equal mass.



Which one of the following correctly describes the velocities of the two bodies after the collision?

	velocity of X	velocity of Y
A	$\frac{v}{2}$	$\frac{v}{2}$
B	$-\frac{v}{2}$	$\frac{v}{2}$
C	$-v$	0
D	0	v

(Total 1 mark)



- 19 A ball **X** is projected horizontally from a certain point at the same time as a ball **Y** of the same diameter but twice the mass is released from rest and allowed to fall vertically from the same level. Air resistance is negligible. Which one of the following will occur?

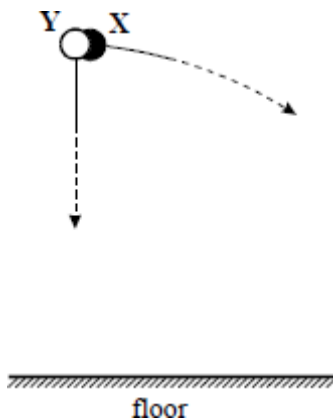

- A **Y** will hit the floor just before **X**
- B **X** will hit the floor just before **Y**
- C **X** and **Y** will hit the floor at the same time
- D **Y** hits the floor while **X** is half way to the floor

(Total 1 mark)

- 20 A lunar landing module is descending to the Moon's surface at a steady velocity of 10.0 m s^{-1} . At a height of 120 m a small object falls from its landing gear. Assuming that the Moon's gravitational acceleration is 1.60 m s^{-2} , at what speed, in m s^{-1} does the object strike the Moon?

- A 22.0
- B 19.6
- C 16.8
- D 10.0

(Total 1 mark)